

BATHWARE

2024 Collection



The name you can always **TRUST..**

aptec[®]
CERAMIC



“

The name
you can
always

TRUST...

Providing the most reliable and valued product and solutions in the ceramic world...



Welcome to **OPEC CERAMIC** Where you can find the sharp vision of marketing, global network and powerful backbone of quality. The company cares the vision to cater world class Ceramic Sanitaryware. It believes in superior quality of Ceramic Sanitaryware with a sharp vision on modern technology with modernized art work.

"A Sanitaryware is a man-made piece of hard-wearing material such a Stone, Stoneware or even Glass."

In our endeavour of Innovation & Revolutionize the Indian Ceramic Manufacturing Industry we installed the Latest & Most Advanced Italian Technology to manufacture Ceramic & Vitrified Sanitaryware with Global Standards having European Designs.

OPEC is determination to become one of the best Global Ceramic Brand and always strive for outstanding quality and revolutionary design concepts to exceedingly gratify the highest aspirations of Global Consumers having fondness toward International quality, Contemporary Designs and Accentuated Aesthetics

The Allison Vehicle Environmental Test Center (as seen above) is an industry leading facility that allows OEMs, body builders, suppliers and end users to satisfy their medium and heavy duty vehicle testing needs in a single, environment controlled location year round.





CONTENTS

06	One Piece
08	One Piece Basin
10	Pedestal Basin
13	Table Top Basin
15	Wall Hung Basin
18	Floor Mount
19	Wall Hung
20	Water Closet
21	Pan
22	Urinals

DESIGNER SERIES

One Piece	24
Floor Mount	25
One Piece Basin	26
Pedestal Set	37
Wall Hung Basin	49
Table Top	51
Pan	54
EWC	58
EWC Tank & Seat Cover	59
Technical Specification	60

THE ONLY
PLACE
WHERE
SUCCESS
COMES BEFORE
WORK
IS IN THE
DICTIONARY





ONE PIECE

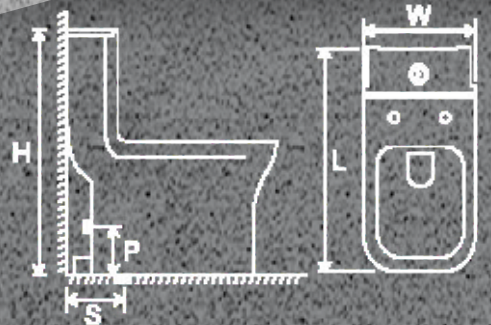

101 - SENTRO

702 x 366 x 673mm

S trap 225mm | P trap 180 mm



102 - COMBO

657 x 357 x 692mm

S trap 225mm | P trap 180mm



104 - CRYSTAL

688 x 355 x 730mm

S trap 100mm & 225mm



105 - EUROPA

695 x 355 x 725mm

S trap 225mm | P trap 180mm



106 - BELINO

647 x 350 x 725mm

S trap 225mm | P trap 180mm



107 - TERRA

638 x 342 x 694mm

S trap 225mm | P trap 180mm



108 - CRUISE - 5D

665 x 340 x 760mm

SYPHONIC S trap 225mm & 300mm



109 - SKODA

620 x 350 x 720mm

S trap 225mm



110 - LEXUS

640 x 355 x 710mm

S trap 225mm | P trap 180mm



111 - DIAMOND

675 x 375 x 760mm

S trap 225mm | P trap 180mm



118 - SKY - 5D

648 x 360 x 748mm

SYPHONIC S trap 225mm



119 - SPACE - 6D

661 x 350 x 638mm

SYPHONIC S trap 225mm



ONE PIECE BASIN





201 - SILVER
460 x 460 x 804mm



202 - FIONA
415 x 415 x 805mm



203 - CROWNY
400 x 400 x 830mm



204 - CRETA
435 x 435 x 800mm



205 - CARNIVAL
370 x 472 x 810mm



206 - CAPSULE
478 x 362 x 804mm

PEDESTAL BASIN





207 - VICTORIA SET
613 x 490 x 880mm



208 - CAPRI SET
635 x 500 x 910mm



209 - POLO SET
570 x 400 x 858mm



210 - MINI POLO SET
460 x 338 x 800mm



211 - SOPHIA SET
550 x 450 x 860mm



212 - STAR GOLD SET
590 x 470 x 890mm



213 - REPOSE SET
520 x 420 x 880mm



214 - SUPREME SET
540 x 440 x 850mm



215 - MINI STERLING SET
580 x 445 x 920mm



216 - BIG STERLING SET
660 x 520 x 932mm



217 - SIMONA SET
565 x 430 x 855mm



218 - ALTIS SET
560 x 400 x 869mm



219 - GLORY SET
450 x 370 x 760mm

TABLE TOP BASIN



TABLE TOP BASIN



301 - TORRUS
420 x 348 x 160mm



302 - DIAMOND
578 x 365 x 118mm



303 - LUMINA
446 x 430 x 130mm



304 - MARS
480 x 365 x 120mm



305 - CLASSIC
456 x 344 x 133mm



306 - VIVO
530 x 334 x 134mm



307 - PEARL
558 x 403 x 110mm



308 - LORDS
470 x 375 x 127mm



309 - CURLY
460 x 390 x 170mm



310 - LATINA
370 x 485 x 135mm



311 - CUBE
610 x 400 x 135mm

WALL HUNG BASIN



401 - REPOSE
572 x 433 x 211mm



402 - BASIN
510 x 418 x 183mm



403 - EXOTICA
490 x 365 x 177mm



404 - RANI
445 x 320 x 200mm



405 - CROMA
460 x 338 x 160mm



406 - BRIO
460 x 314 x 152mm



407 - CROWNY
480 x 355 x 180mm



408 - FLORA
297 x 233 x 177mm



409 - CORNER
425 x 425 x 210mm



410 - SWING
370 x 295 x 158mm



411 - PRIME
458 x 358 x 180mm



412 - ANTICA
468 x 304 x 165mm



413 - ESA
340 x 228 x 150mm



414 - LIVA
433 x 305 x 114mm



415 - KIA
274 x 320 x 130mm



416 - LIZA
330 x 300 x 140mm



417 - GOLDEN
455 x 355 x 185mm



418 - MOON
406 x 336 x 130mm



419 - SONA
585 x 440 x 165mm



420 - AUDI
415 x 230 x 115mm



421 - GLORY
450 x 370 x 160mm

FLOOR MOUNT



501 - APPLE
525 x 398 x 350mm



502 - PLUTO
545 x 405 x 350mm



503 - RAPID
500 x 390 x 350mm



504 - DOME
530 x 360 x 400mm



505 - COSMO
520 x 360 x 400mm



601 - DELITE
550 x 370 x 350mm



602 - SMART
555 x 480 x 350mm



603 - ROYAL
510 x 365 x 355mm



604 - CAMEO
505 x 344 x 340mm



605 - SANYO
535 x 350 x 335mm



606 - ZETA
513 x 363 x 340mm



607 - CREMA
520 x 340 x 380mm



608 - SIGMA
530 x 350 x 360mm



701 - EWC-S
478 x 366 x 410mm



702 - ANGLO - S
420 x 430 x 400mm



703 - CONCEALED
460 x 385 x 420mm



704 - EWC SQUARE
470 x 355 x 400mm



705 - EWC-P
478 x 366 x 410mm



706 - ANGLO - P
520 x 430 x 400mm



707 - AQUA
770 x 400 x 700mm



708 - ITALIAN
770 x 410 x 650mm



708 - ITALIAN P
660 x 360 x 810mm



709 - TOYOTA
630 x 370 x 800mm



801 - 200P DELUXE
527 x 413 x 223mm



802 - 230P DELUXE
583 x 432 x 231mm



803 - 200P HEAVY
520 x 418 x 272mm



804 - 230P HEAVY
610 x 447 x 275mm



805 - ACUPRESSURE PAN
515 x 415 x 270mm



806 - MD PAN
520 x 400 x 210mm



807 - CT PAN
510 x 405 x 160mm



GENTS URINAL
410 x 330 x 255mm



LADIES URINAL
440 x 350 x 100mm



HALF STALL URINAL
600 x 395 x 105mm



MINI URINAL
410 x 250 x 190mm



MINI HALF STALL URINAL
400 x 300 x 260mm



P TRAP



BIG P TRAP

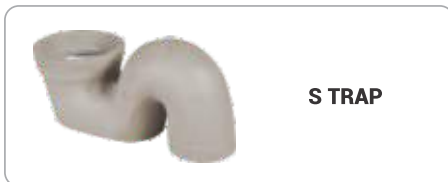

S TRAP



DESIGNER

COLLECTION



101 (A) - COBALT BLUE

702 x 366 x 673mm

S trap 225mm | P trap 180 mm



101 (B) - MAGENTA

702 x 366 x 673mm

S trap 225mm | P trap 180 mm



101 (C) - COFFEE

702 x 366 x 673mm

S trap 225mm | P trap 180 mm



101 (D) - RUSTIC BLACK

702 x 366 x 673mm

S trap 225mm | P trap 180 mm



501 A - SANITO
525 x 398 x 350mm



501 B - WOODEN
525 x 398 x 350mm



501 C - BLACK MARBLE
525 x 398 x 350mm



501 D - WHITE MARBLE
525 x 398 x 350mm



501 E - STICKER MARBLE
525 x 398 x 350mm



501 F - COFFEE MARBLE
525 x 398 x 350mm

Crowny



4001
CROWNY ONE PIECE BASIN
400 x 400 x 830mm



4002
CROWNY ONE PIECE BASIN
400 x 400 x 830mm



4003
CROWNY ONE PIECE BASIN
400 x 400 x 830mm

Crowny



4004
CROWNY ONE PIECE BASIN
400 x 400 x 830mm



4005
CROWNY ONE PIECE BASIN
400 x 400 x 830mm



4006
CROWNY ONE PIECE BASIN
400 x 400 x 830mm



4007
CROWNY ONE PIECE BASIN
400 x 400 x 830mm



4008
CROWNY ONE PIECE BASIN
400 x 400 x 830mm



4009
CROWNY ONE PIECE BASIN
400 x 400 x 830mm

Creta



5001 - CRETA
435 x 435 x 800mm



5002 - CRETA
435 x 435 x 800mm



5003 - CRETA
435 x 435 x 800mm



5004 - CRETA
435 x 435 x 800mm



5005 - CRETA
435 x 435 x 800mm



5006 - CRETA
435 x 435 x 800mm

Capsule



6001 - CAPSULE
478 x 362 x 804mm



6002 - CAPSULE
478 x 362 x 804mm



6003 - CAPSULE
478 x 362 x 804mm



6004 - CAPSULE
478 x 362 x 804mm



6005 - CAPSULE
478 x 362 x 804mm



6006 - CAPSULE
478 x 362 x 804mm

Fiona



7001 - FIONA
415 x 415 x 805mm



7002 - FIONA
415 x 415 x 805mm



7003 - FIONA
415 x 415 x 805mm



7004 - FIONA
415 x 415 x 805mm



7005 - FIONA
415 x 415 x 805mm



7006 - FIONA
415 x 415 x 805mm

Fiona



7007 - FIONA
415 x 415 x 805mm



7008 - FIONA
415 x 415 x 805mm



7009 - FIONA
415 x 415 x 805mm



7010 - FIONA
415 x 415 x 805mm



7011 - FIONA
415 x 415 x 805mm



7012 - FIONA
415 x 415 x 805mm

Glassia



8001 - GLASSIA
402 x 402 x 794mm



8002 - GLASSIA
402 x 402 x 794mm



8003 - GLASSIA
402 x 402 x 794mm



8004 - GLASSIA
402 x 402 x 794mm

Glassia



8005 - GLASSIA
402 x 402 x 794mm



8006 - GLASSIA
402 x 402 x 794mm



8007 - GLASSIA
402 x 402 x 794mm



8008 - GLASSIA
402 x 402 x 794mm



8009 - GLASSIA
402 x 402 x 794mm



8010 - GLASSIA
402 x 402 x 794mm

Carnival



9001 - CARNIVAL
370 x 472 x 810mm



9002 - CARNIVAL
370 x 472 x 810mm



9003 - CARNIVAL
370 x 472 x 810mm



9004 - CARNIVAL
370 x 472 x 810mm



9005 - CARNIVAL
370 x 472 x 810mm



9006 - CARNIVAL
370 x 472 x 810mm

Silver



10001 - SILVER
460 x 460 x 804mm



10002 - SILVER
460 x 460 x 804mm



10003 - SILVER
460 x 460 x 804mm



10004 - SILVER
460 x 460 x 804mm



10005 - SILVER
460 x 460 x 804mm

Fiona Plus



11001 - FIONA PLUS
455 x 455 x 794mm



11002 - FIONA PLUS
455 x 455 x 794mm



11003 - FIONA PLUS
455 x 455 x 794mm

Big Sterling



1101 - ALPINE BLUE
660 x 520 x 932mm



1102 - RED
660 x 520 x 932mm



1103 - ORANGE
660 x 520 x 932mm



1104 - MINT GREEN
660 x 520 x 932mm



1105 - BLUE
660 x 520 x 932mm

Polo



1201 - MINT GREEN
570 x 400 x 858mm



1202 - ALPINE BLUE
570 x 400 x 858mm



1203 - MAGENTA
570 x 400 x 858mm



1204 - BURGUNDY
570 x 400 x 858mm



1205 - AQUA GREEN
570 x 400 x 858mm



1206 - RED
570 x 400 x 858mm

Polo



1207 - BLACK
570 x 400 x 858mm



1208 - COFFEE
570 x 400 x 858mm



1209 - ORANGE
570 x 400 x 858mm



1210 - BLUE
570 x 400 x 858mm



1211 - NEO GREEN
570 x 400 x 858mm



1212 - COBALT BLUE
570 x 400 x 858mm

Star Gold



1301 - MAGENTA
590 x 470 x 890mm



1302 - BLUE
590 x 470 x 890mm



1303 - BURGUNDY
590 x 470 x 890mm



1304 - AQUA GREEN
590 x 470 x 890mm



1305 - WOODEN
590 x 470 x 890mm



1306 - ALPINE BLUE
590 x 470 x 890mm

Star Gold



1307 - CROSS BLACK
590 x 470 x 890mm



1308 - RED BROWN
590 x 470 x 890mm



1309 - MINT GREEN
590 x 470 x 890mm



1310 - ORANGE
590 x 470 x 890mm



1311 - RED
590 x 470 x 890mm



1312 - COFFEE
590 x 470 x 890mm

Star Gold



1313 - COBALT BLUE
590 x 470 x 890mm



1314 - NEO PINK
590 x 470 x 890mm



1315 - RED FLOWER
590 x 470 x 890mm



1316 - BLACK
590 x 470 x 890mm



1317 - OASIS GREEN
590 x 470 x 890mm



1318 - NEO GREEN
590 x 470 x 890mm

Mini Polo



1401 - ALPINE BLUE
460 x 338 x 800mm



1402 - MAGENTA
460 x 338 x 800mm



1403 - AQUA GREEN
460 x 338 x 800mm



1404 - BURGUNDY
460 x 338 x 800mm



1405 - RED
460 x 338 x 800mm



1406 - ORANGE
460 x 338 x 800mm

Mini Polo



1407 - COFFEE
460 x 338 x 800mm



1408 - WALKER YELLOW
460 x 338 x 800mm



1409 - BLACK
460 x 338 x 800mm



1410 - BLUE
460 x 338 x 800mm



1411 - MINT GREEN
460 x 338 x 800mm

Victoria



1501 - COFFEE MARBLE
613 x 490 x 880mm



1502 - AQUA GREEN
613 x 490 x 880mm



1503 - BLACK MARBLE
613 x 490 x 880mm

Repose



1601 - ALPINE BLUE
635 x 500 x 910mm



1602 - AQUA GREEN
635 x 500 x 910mm



1603 - WOODEN
635 x 500 x 910mm



1604 - BLUE
635 x 500 x 910mm



1605 - MAGENTA
635 x 500 x 910mm



1606 - BURGUNDY
635 x 500 x 910mm

Rustic



2101
SUPRIME MAGENTA
635 x 500 x 910mm



2102
SUPRIME RED
540 x 440 x 850mm



2103
SUPRIME ALPINE BLUE
540 x 440 x 850mm



2201
MINI STERLING MAGENTA
580 x 445 x 920mm



2202
MINI STERLING RED
580 x 445 x 920mm



2203
MINI STERLING COFFEE
580 x 445 x 920mm

Rustic



3201 - BLACK RUSTIC
468 x 304 x 165mm



3202 - RED BROWN RUSTIC
468 x 304 x 165mm



3203 - MAGENTA RUSTIC
468 x 304 x 165mm



3204 - COFFEE RUSTIC
468 x 304 x 165mm

Rani



3401 - RED
445 x 320 x 200mm



3402 - ALPINE BLUE
445 x 320 x 200mm



3403 - MAGENTA
445 x 320 x 200mm

Antica



3301 - ALPINE BLUE
468 x 304 x 165mm



3302 - COBALT BLUE
468 x 304 x 165mm



3303 - BLACK
468 x 304 x 165mm



3304 - MINT GREEN
468 x 304 x 165mm



3305 - MAGENTA
468 x 304 x 165mm



3306 - ORANGE
468 x 304 x 165mm



3307 - BLUE
468 x 304 x 165mm



3308 - WALKER YELLOW
468 x 304 x 165mm



3309 - BURGUNDY
468 x 304 x 165mm

Torus

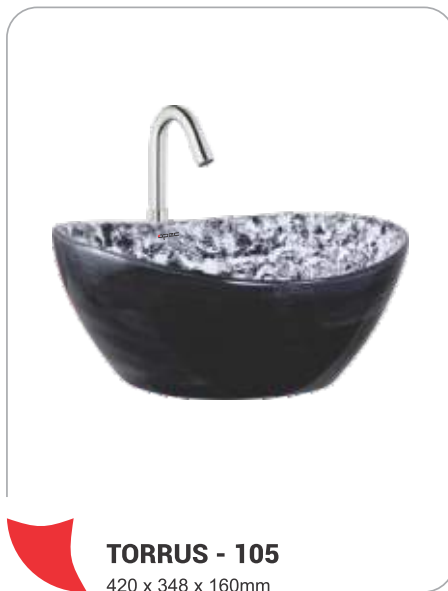
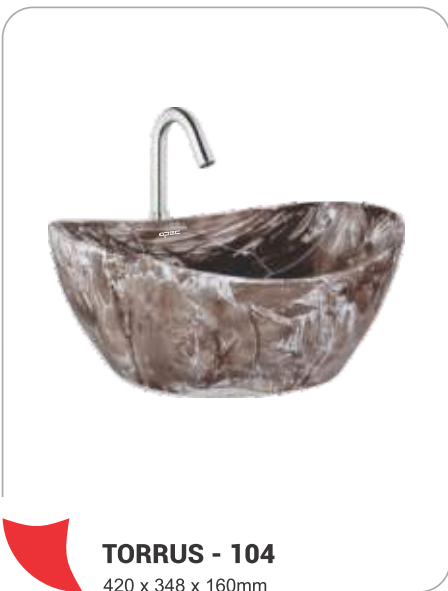
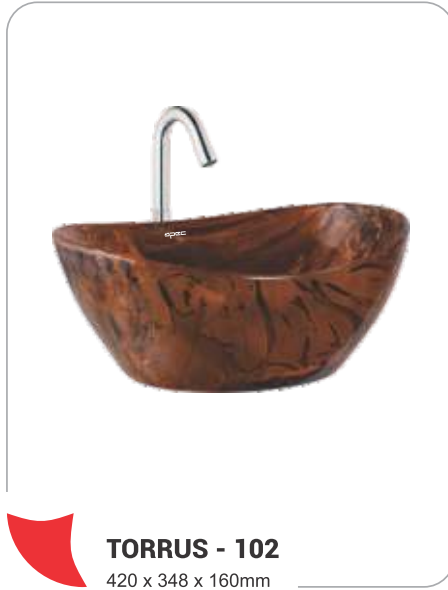

Classic



CLASSIC -201
456 x 344 x 133mm



CLASSIC -202
456 x 344 x 133mm



CLASSIC -203
456 x 344 x 133mm



CLASSIC -204
456 x 344 x 133mm



CLASSIC -205
456 x 344 x 133mm



CLASSIC -206
456 x 344 x 133mm



CLASSIC -207
456 x 344 x 133mm



CLASSIC -208
456 x 344 x 133mm



CLASSIC -209
456 x 344 x 133mm

Classic



Lords

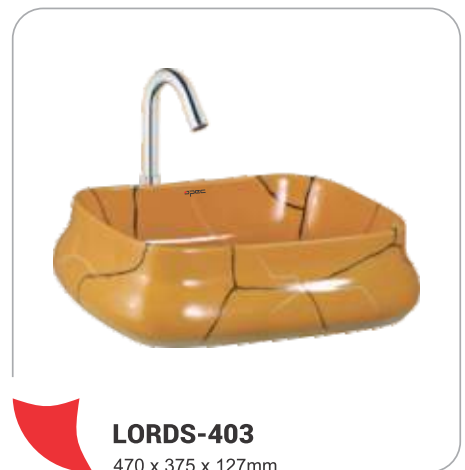
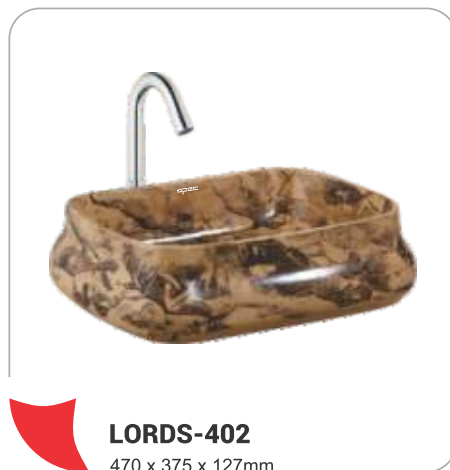





PAN ACUPRESSURE FOOTBALL

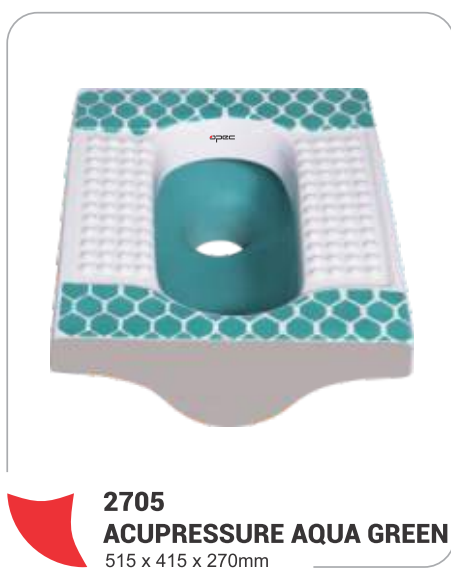
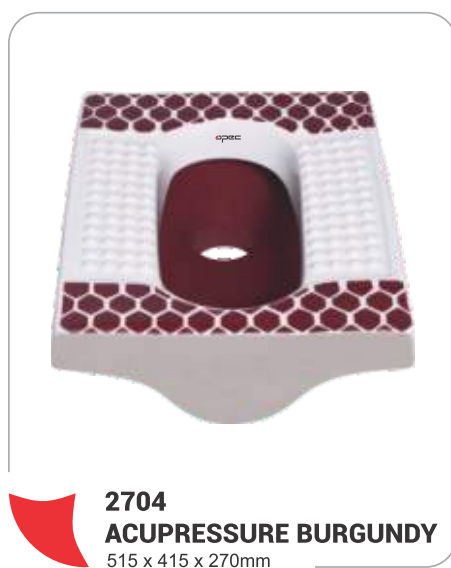



2801 - ALPINE BLUE
520 x 418 x 272mm



2802 - MINT GREEN
520 x 418 x 272mm



2803 - RED
520 x 418 x 272mm



2804 - ORANGE
520 x 418 x 272mm



2805 - AQUA GREEN
520 x 418 x 272mm



2806 - BURGUNDY
520 x 418 x 272mm



2807 - RED BROWN
520 x 418 x 272mm



2808 - COBALT BLUE
520 x 418 x 272mm



2809 - MAGENTA
520 x 418 x 272mm





COLOUR RANGE

REGULAR

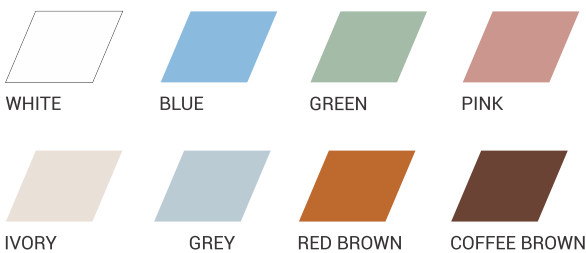

SPECIAL



EXCLUSIVE



RUSTIC





3501
SIDE HANDLE



3502
GOLD TOP PUSH



3503
PLATINUM DUAL FLUSH



3504
ANTIQUE FRONT PUSH



3505
SILVER DUAL FLUSH



3506
EWC SEAT COVER



3507
ANGLO SEAT COVER



3508
SOFT CLOSE SEAT COVER

WALL HUNG BASIN

- 1) The rag bolt should be first grouted into the wall using cement/concrete, (as shown) as per distance between slots provided in the wash basin. The bolts should be fixed perpendicular to the wall. Allow cement/concrete to set. Check if the Rag Bolts are firmly fixed. Fix the Wash Basin in the bolt using Nut & Washer.
- 2) If brackets are use, prefer Nylon or Aluminium instead of iron brackets as it tends to rust.
- 3) If small basins are screwed to wall, use Nylon washers and steel screws.
- 4) While fixing waste outlet, ensure that the rubber washer is placed on the outlet under the basin.

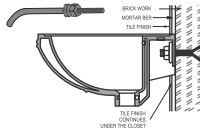

COUNTER WASH BASIN

At the beginning

1. A skilled or experienced person should install counter lavatories.
2. Avoid using adhesive with this product.
3. Check the waste area and supply tubing if required.
4. Do not open the lavatory from its protective carton until you are ready for installation.
5. Please follow all local building and plumbing codes.

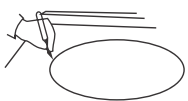

MATERIAL & TOOLS

Measure tape, keyhole or sober sow, Hammer, Glasses, Rage or Paper towelling, Drill (1/2 dia, drill bit or larger), Pencil, sealant, sharp knife or scissors.

INSTALLATION OF LAVATORY

Please Note : Please install it in a way that future removal from underneath the counter top is possible without damaging the counter top.

1. Please check the desired location for clearance between the back splash, faucet, fixture and cabinet.
2. Please cut the template.
3. Please carefully trace the template on the counter top as directed.
4. Please mark the faucet hole centerline on the counter top.
5. Please drill a 1/2" pilot on the inside of the cut line.

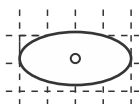

For Wood Counter tops:

1. Mark and per-drill the wood screw holes at the locations shown on the template.
2. Waterproof any exposed areas of wood.

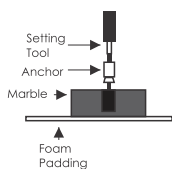

For Marble Counter tops:

1. Position the counter top upside down on foam padding to protect the surface. Mark and drill 3/6" holes 5/8" deep at the locations shown on the template.
2. Use a setting tools and hammer to secure the anchors.



For All Installations :

1. If the counter top has not been installed, install it at this time.
2. Drill the faucet holes according to the faucet installation instructions.
3. Install the foucet to the counter top according to the manufacture's instructions.
4. Install the drain to the lavatory according to the manufacturer's instructions.

INSTALLATION DETAILS OF WALL HUNG

CONCEALED WALL HUNG

1. If the wall is going to be plastered for a thickness of 12 mm and a tile thickness of 6-7 mm, the projection of the bolts from the finished wall should be 66 mm only.
2. If the thickness of Plastering and tile is less than the dimensions mentioned above, the bolts that are supplied along with the bracket should be moved into the wall by using a suitable spacer washer between the bolt head and the bracket frame.
3. The bracket should be buried into the floor so that the height from the center line of the bolt to the surface of the finished floor is 320 mm.

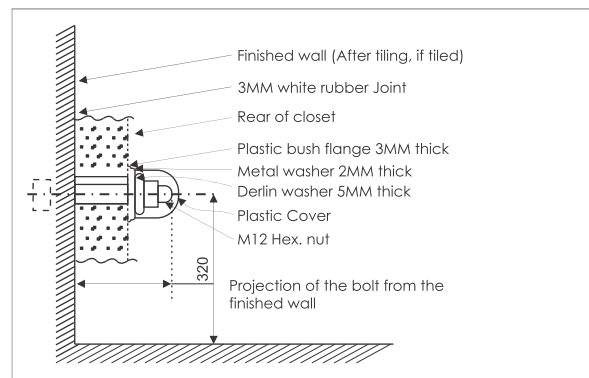
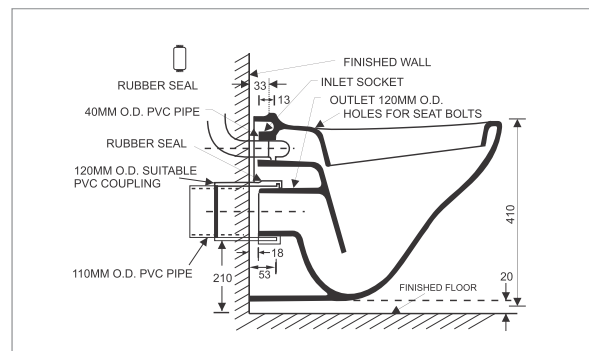

MAINTENANCE

Like any other part of your houses, the bathroom can be made to look great and made to last long if it is taken care of regularly. To make your bathroom beautiful here are some valuable tips.

Wash Basin

A mild detergent can be used to wash the basin at least once a day. After washing, the basin should be wiped out clearly to avoid water stains.

Closets

Cleanser like harpic can be used to clear the closet with soft plastic brush, at least once a day. To avoid minute discoloring, after flushing the toilet give it a once over with the soft brush.

Keep the toilet brush handy in a convenient stand nearby. In case toilet and basins, if there has been no maintenance since long period of time, water deposit and discoloration can from on the surface of areas that get wet, In such causes, these stains/marks can be removed with the help of a solution of dilute hydrochloric acid. Clean with a soft cotton cloth and warm water with soap. Do not use thinner, dry cleaning liquids or powder paste. Use a liquid cleaner at least twice a week. Use Brasso or car rubbing compound and than polish with a cloth to remove fine scratches.

ITEM	PROBLEM	PROBABLE REASONS	CORRECTIVE ACTIONS
ONE PIECE CLOSET	1. Water not coming in bowl area while flushing	Mechanism inside tank may not be working properly	Change the center pump of mechanism
		There is no water in flush tank	Increase the ball cock height to the max level
	2. Water is continuously leaking closet inside the bowl	Mechanism inside tank may not be working properly	Change the center pump of mechanism
	3. water quantity insufficient for effective flushing	Ball cock height adjusted at lower level	Increase the ball cock height to the max level
	4. Uneven flow of water from both side of closet	Closet is not levelled properly	Closet should be in proper level
WALLHUNG WATER CLOSET	1. Water not coming in bowl area while flushing	Flush valve may not be working properly/ concealed cistern is not working properly	Should change flush valve I concealed cistern
		Flush pipe is inserted up the end of inlet hole	Insert the flush pipe up to the end of inlet
	2. Water is continuously leaking inside the bowl	Closet is not levelled properly	Closet should be in proper level
	3. Water quantity insufficient for effective flushing	Connection between closet outlet and drainage pipe is not proper	Proper connection should be made by experienced plumber
WASH BASINS / TABLE TOP	1. Overflow choked and foul bad odour	Waste coupling used may be full threaded	Waste coupling should be replaced by slot cut coupling
	2. Water deposit on tap platform area and inside bowl area	Basin is not fixed in level of bracket is not in level	Should be done by proper levelling
	3. There is no tap hole in basin	Tap hole can be semi punched from of inlet hole	Tap hole should be created by plumber from semipunched area
EWC / PAN / ANGLO INDIAN	1. Water not coming in bowl area while flushing	Flush bend is not inserted up to the end of inlet hole	Insert the flush pipe up to the end of inlet (for pan closet: check whether flush pipe is not covering flush hole which is in both side of inlet wall)
		Closet / Pan may not be levelled	Should be done by proper levelling



DIRT FREE



ECO FRIENDLY



WATER SAVING



GERM FREE



www.opecceramic.com

Our Presence in Worldwide



Our Group of Companies

